



YANMAR

ZERO TAIL SWING MINI EXCAVATOR

Vi017

[Gross] 10.1kW <13.5hp>



* The machine in the picture is equipped with optional parts.



Improved work efficiency. A mini excavator capable of making tight turns.

Easier, more intuitive, reliable and productive. Equipped with plenty of features that maximize comfort, reliability and safety, the advanced True Zero Tail Swing ViO17 is suitable for a wide range of worksites and operations.



* Pictures shown are for illustration purpose only. * The images shown here are for promotional purposes.
* The image may differ from the actual model on sale. * The machine in the picture is equipped with optional parts.
* Ground the bucket when leaving the operator's seat. *Work in accordance with the relevant laws when operating the excavator.

Details of Vi017

Features

ROPS¹/FOPS² four pillar canopy to protect the operator

►Page 9

Spring steel cylinder rod guards to prevent damage to the hydraulic cylinder

►Page 7

3 pump hydraulic system & wrist control lever

►Page 9

A standard safety lever to prevent danger caused by an unexpected malfunction

►Page 9

Boom light is installed inside the structure to protect it from damage

►Page 7

Fuel tank & radiator that can be easily maintained

►Page 10





Easy maintenance of hydraulic equipment and return filter

►Page 10

Sliding variable undercarriage

►Page 6

Fuel filler port in ease of fueling can refuel with a easy posture

►Page 8

The battery cell motor and generator can be maintained with ease

►Page 10

*The images shown here are for promotional purposes. * The image may differ from the actual model on sale.
*The machine in the picture is equipped with optional parts. * Ground the bucket when leaving the operator's seat.
*1 ROPS: Roll-Over Protective Structure(A structure to protect the operator wearing a seat belt, in case the machine rolls over)
*2 FOPS: Falling Object Protective Structure

Various abilities required on worksites all packed into one machine.

The compact & powerful ViO17 exhibits outstanding work performance in narrow worksites. Easy to use, reliable, and safe. The mini excavator works smoothly while fulfilling all of its required duties on the worksite.



● True Zero Tail Swing



Works efficiently and can be operated without worrying about the tail swing. The excavator body stays within the machine width. This helps reduce the operator's efforts and work time.

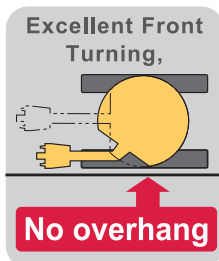

● Outstanding work performance

Unlike the machines in this class, with the best combination of engine and hydraulic systems, this machine exhibits powerful performance. Operators can now work with even more efficiency.



Clean & silent

● Equipped with an eco-friendly engine

With the environment and people in mind, YANMAR's clean emission TNV engine is quiet, while also providing plenty of power.

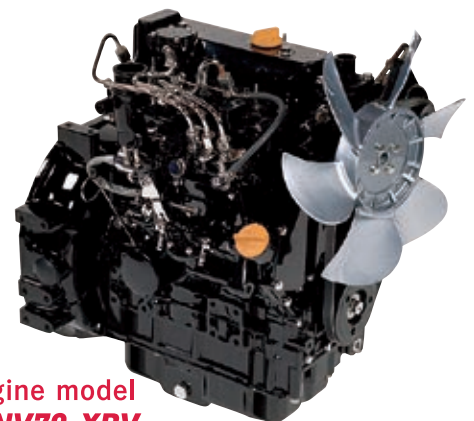

Engine model
3TNV70-XBV
Engine output
10.1kW

*Picture of engine shown for illustration purpose only.

YANMAR's original sliding variable undercarriage

● Sliding variable undercarriage

YANMAR'S Mini Excavator allows ease of access to narrow places and ensures stable workability. The Mini Excavator is strongly built and does not wobble (or shake) when the undercarriages are extended to the maximum.

Moreover, when the distance between the undercarriages is extended, the Mini Excavator forcibly discharges the mud in the sliding pipes, thus performing highly efficient work in any place regardless of the size of the area.

● Simple folding variable Blade

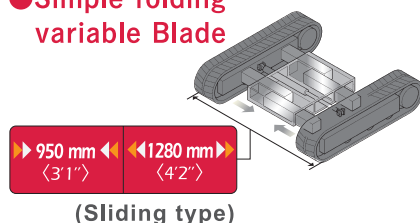

● 3 Hydraulic Pump System

Delivers a strong performance on-par with bigger machines.

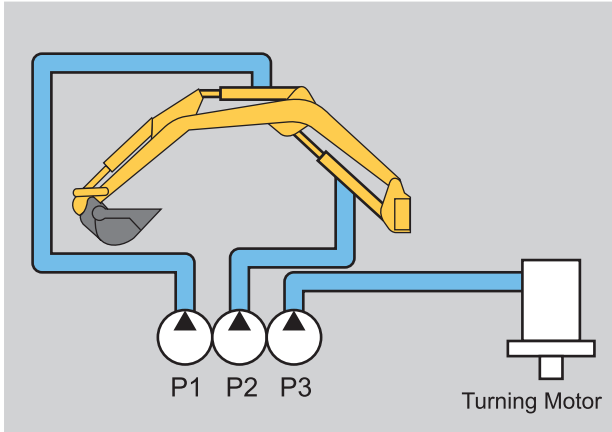

Smooth even while using both the boom and arm during turning!

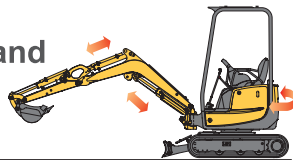

● Underside protector



High strength cast iron underside protectors are used to protect the frame corners.

● A well-balanced work range



The bucket can dig deeper, and its operation range also includes the area in front of it. The minimum dump height is enough to dump materials into a truck, so the continuous work of digging → turning → dumping is smooth.

● Spring steel cylinder rod guards

The cylinder rod is protected by the spring steel structure. Scratches caused by debris or collision are greatly reduced thanks to the spring steel's ability to absorb impact. Additionally, they are highly durable and unlikely to bend, giving the operator a sense of safety. Metal sheeting shields the cylinder tubes providing full protection to cylinders, regardless of whether they are extended or retracted.



● Built-in boom light

Protects the light from damage.



● Blade cutting edge

Made with highly tensile and durable steel.

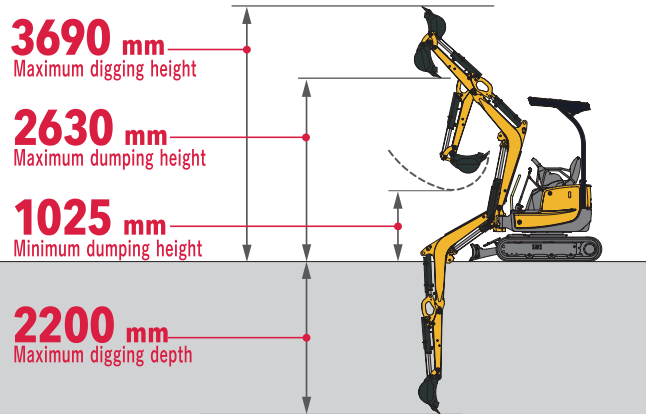

* The images shown here are for promotional purposes. * The image may differ from the actual model on sale.
* The machine in the picture is equipped with optional parts. * Ground the bucket when leaving the operator's seat.

Easy to use, inspect, and maintain

Large space for unrestricted operation

Even a zero tail swing, large operation space of ViO17 provides easy and unrestricted operating space. It reduces operating stress and fatigue.

● External power outlet (12V)

Can also be used to charge cell phones.



● Improvement in ease of fueling

Allows fueling in an easy posture.

The opening of the fuel tank is located in front of the control lever on the right side. The Mini Excavator can be fueled with ease from a polyethylene fuel tank placed on the driver's seat floor.



● Walk-through

Easy to get on & off
Get on & off from either side.



● Safety lever mechanism

Prevents risks resulting from abrupt malfunctions.

● Neutral Lever Lock

The Mini Excavator is provided with safety levers that lock the movement such as operation of the excavating, turning and running of Mini Excavator.

● Engine Neutral Start Mechanism

The engine does not start unless the lever is locked, thus preventing the abrupt movement of the Mini Excavator resulting from malfunctions.



● Large traveling pedal

Large traveling pedals make it much more easier & more comfortable for the operator.



Broad range of sight for safe and comfortable operation

The standard, lightweight canopy complies with ROPS and FOPS standards to protect the operator in case the excavator rolls over and from falling objects. No wall hinders the view. Work is safe and efficient.



● ROPS*1/ FOPS*2 four pillar canopy

Meets international protection standards to ensure safer work than ever before.



● Manual case

All manuals are right there!

The space behind the backrest of the seat accommodates manuals, magazines, and booklets with ease.



● Wrist control lever

Ensures ease of operation and smooth work.

Lever operation from the wrist and the armrest alleviate the fatigue of a long workday.



*The images shown here are for promotional purposes. * The image may differ from the actual model on sale.

*The machine in the picture is equipped with optional parts. * Ground the bucket when leaving the operator's seat.

*1 ROPS: Roll-Over Protective Structure(A structure to protect the operator wearing a seat belt, in case the machine rolls over)

*2 FOPS: Falling Object Protective Structure.

Simple engine access brings major improvements to maintenance efficiency.



Daily inspection

You can open the hood at the back to quickly inspect/refill engine oil, clean the air cleaner, and fill in the coolant sub-tank.

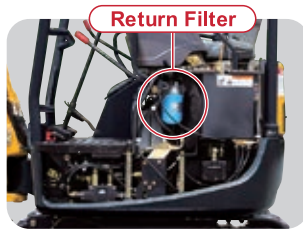

Hydraulic equipment and return filter maintenance

You can remove the left side-cover to easily access and maintain the hydraulic equipment and return filter. In addition, you can easily replace the return filter without getting your hands dirty as the filter is a cartridge.



Starter motor and generator maintenance

You can open the cover below the operator's seat to easily access and maintain the battery, starter motor, and generator.



Fuel tank and radiator maintenance

You can remove the right side-cover to easily access and maintain the fuel tank and radiator.

ViO17 corresponds to many other functions.

*These functions differ depending on the region. Please contact your YANMAR dealer for further information.

● Pattern change valve (2way/4way)



● P.T.O. specification (VAE *pipe)



● Steel crawler

* [P.T.O. specification] VAE : Attachment pipe on the arm end

The Unsung Heroes Who Build Our Towns And Cities

You build the infrastructure and the foundations in our towns and cities. Transforming the places where we stand today, into dreams of tomorrow. You are the unsung hero.

The YANMAR mission is to provide machines and services that allow you to reach your full potential.

Built tough and with comfort in mind, YANMAR construction equipment will help you get the job done with ease, regardless of the worksite. When we make machines, we are dedicated to enabling you to perform at your best all of the time.

One example of this is our innovative True Zero Tail Swing Excavators that set the standard for safety and reliability, enabling operators to perform at their best in tight quarters.

YANMAR also manufactured the first compact diesel engines and today we continue to make diesel engines ranging from 4 to 4,800 kW.

Equipped with advanced engines and hydraulic systems, our construction equipment delivers better fuel economy, increased productivity and enhanced operation.



YANMAR is the driving force behind the unsung hero.

BEST PERFORMANCE BY YOUR SIDE

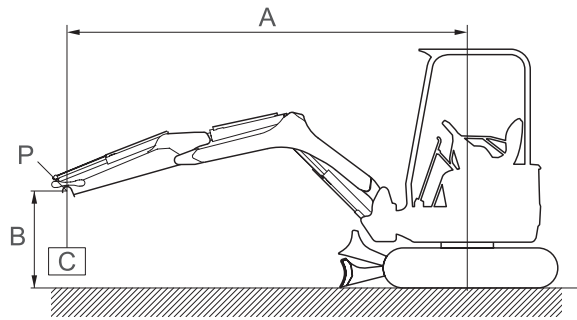
Lifting Capacity











With:
Canopy Type
Rubber Crawler
Without: Bucket

- A : Reach from swing center line [m<in.>]
- B : Load point height [m<in.>]
- C : Lifting load [kg<lbs.>]
- P : Load point
-  : Rating over front
-  : Rating over side or 180 degrees









Blade on ground

Unit : kg <lbs.>

A [m.<in.>]	Max.		2.5<98.4>		2.0<78.7>		Min.	
B [m.<in.>]								
2.0<78.7>	340 *(<749>)	240 <529>	320 *(<705>)	315 *(<694>)	-	-	-	-
1.5<59.1>	350 *(<771>)	220 <485>	370 *(<815>)	370 *(<815>)	425 *(<936>)	420 *(<925>)	-	-
1.0<39.4>	365 *(<804>)	205 <451>	450 *(<992>)	305 <672>	595 *(<1311>)	440 <970>	665 <1466>	555 <1223>
0.5<19.7>	375 <826>	205 <451>	525 *(<1157>)	300 <661>	740 *(<1631>)	425 <936>	920 *(<2028>)	505 <1113>
0<0>	390 *(<859>)	205 <451>	550 *(<1212>)	285 <628>	765 *(<1686>)	400 <881>	1050 *(<2314>)	505 <1113>
-0.5<-19.7>	410 *(<903>)	230 <507>	545 *(<1201>)	290 <639>	735 *(<1620>)	400 <881>	-	-
-1.0<-39.4>	420 *(<925>)	270 <595>	-	-	680 *(<1499>)	405 <892>	-	-

Blade above ground

Unit : kg <lbs.>

A [m.<in.>]	Max.		2.5<98.4>		2.0<78.7>		Min.	
B [m.<in.>]								
2.0 <78.7>	225 <496>	235 <518>	315 *(<694>)	315 *(<694>)	-	-	-	-
1.5<59.1>	205 <451>	215 <473>	305 <672>	370 *(<815>)	420 *(<925>)	425 *(<936>)	-	-
1.0<39.4>	185 <407>	200 <440>	285 <628>	295 <650>	410 <903>	435 <959>	525 <1157>	550 <1212>
0.5<19.7>	185 <407>	200 <440>	280 <617>	295 <650>	390 <859>	415 <914>	470 <1036>	500 <1102>
0<0>	190 <418>	205 <451>	265 <584>	285 <628>	365 <804>	385 <848>	520 <1146>	495 <1091>
-0.5<-19.7>	210 <462>	225 <496>	260 <573>	280 <617>	355 <782>	385 <848>	-	-
-1.0<-39.4>	250 <551>	265 <584>	-	-	375 <826>	405 <892>	-	-

Note :

The lifting load with the asterisk (<*>) mark is limited by hydraulic lifting capacity rather than tipping. The lifting capacity shown in the above list is based on the ISO Standard No. 10567 and represents either 87% of hydraulic lifting capacity or 75% of the tipping load, which is smaller.

● Dimensions

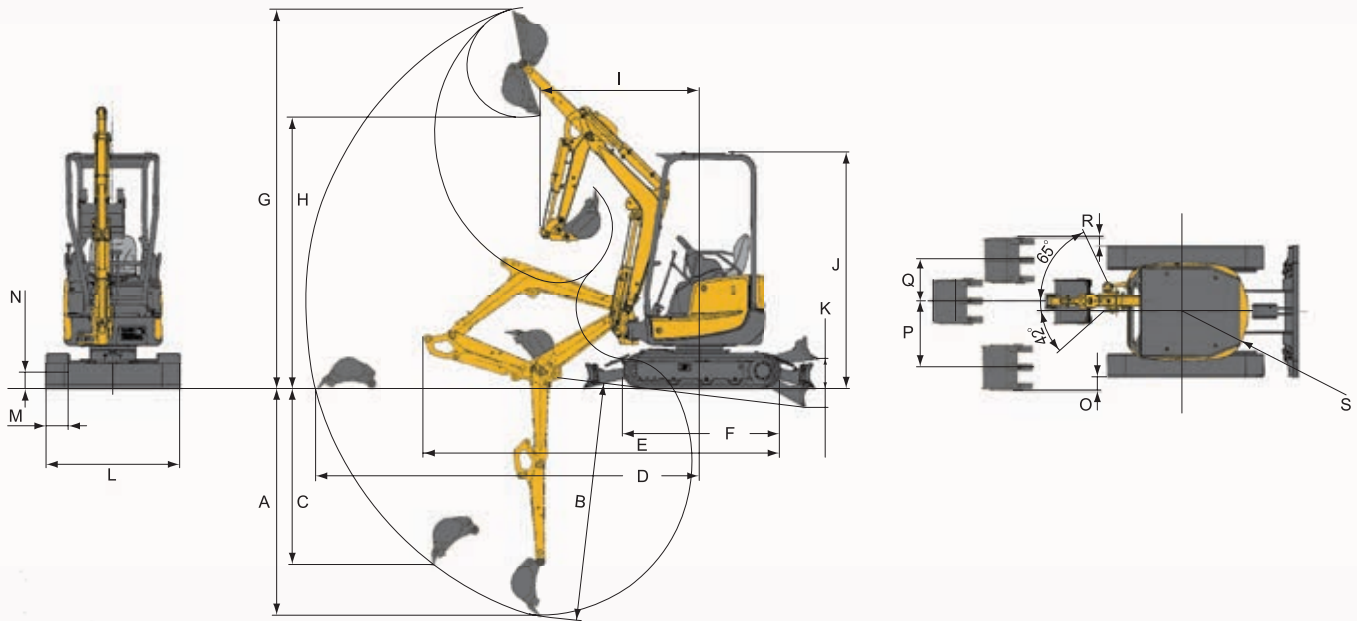

(unit: mm(ft-in))

	A	B	C	D	E	F	G	H	I	J	K	L	M	N	O	P	Q	R	S
Vi017	2200 (7'03")	2310 (7'7")	1850 (6'1")	3710 (12'2")	3450 (11'4")	1525 (5'0")	3690 (12'1")	2630 (8'8")	1535 (5'0")	2300 (7'7")	260 (10")	950(3'1") 1280(4'2")	230 (9")	175 (7")	125 (5")	640 (2'1")	400 (1'4")	85 (3")	R640 (2'1")

Specifications

Model		Vi017	
Type		Canopy	
Operating Weight	Rubber track	1740 (3836) kg (lbs)	
	Steel track	1800 (3969) kg (lbs)	
Engine	Type	Vertical 3 cylinder water-cooled diesel	
	Model	3TNV70-XBV	
	Rated Output	10.1 (13.5) / 2200 kW (hp) / rpm	
Performance	Bucket capacity, standard (ISO heaped)	0.05 (1.77) cu.m (cu.ft)	
	Max Digging Force	Bucket	15.2 (3417) kN (lbf)
		Arm	8.5 (1918) kN (lbf)
	Traveling Speed, High/Low	4.3 / 2.1 (2.7 / 1.3) km/h (MPH)	
	Swing Speed	9.5 RPM	
Boom Swing Angle, (L / R)	42 / 65 degrees		
Ground Contact Pressure	Rubber track	28.6 (4.1) kPa (PSI)	
	Steel track	29.6 (4.3) kPa (PSI)	
Hydraulic System	Pump Capacity	17.6 + 17.6 + 13.2 + 11.2 (4.6 + 4.6 + 3.5 + 2.6) L / min (GPM)	
	Main Relief Set Pressure	20.6 (2987) MPa (PSI)	
Undercarriage	Track type	Rubber	
Blade Dimensions	Width x Height	1280 / 950 x 235 (4'2" / 3'1" x 9") mm (ft-in)	
Fuel tank capacity	L (Gals)	20 (5.3)	

Hydraulic P.T.O.

Model		Vi017	
Specification	Output	MPa (PSI)	L / min (GPM)
			2200RPM
Combined Flow, Double Actions		16.7 (2417)	30.8 (8.1) / 17.5 (4.6)

YANMAR CONSTRUCTION EQUIPMENT CO., LTD.

Promotion Group
 Sales Planning Dept.
 Marketing & Sales Dept.
 1717-1, Oaza Kumano, Chikugo, Fukuoka 833-0055, Japan
 TEL. +81-942-70-8992
 FAX +81-942-53-6855
 yanmar.com

All data subject to change without notice.